

SIZE GUIDE

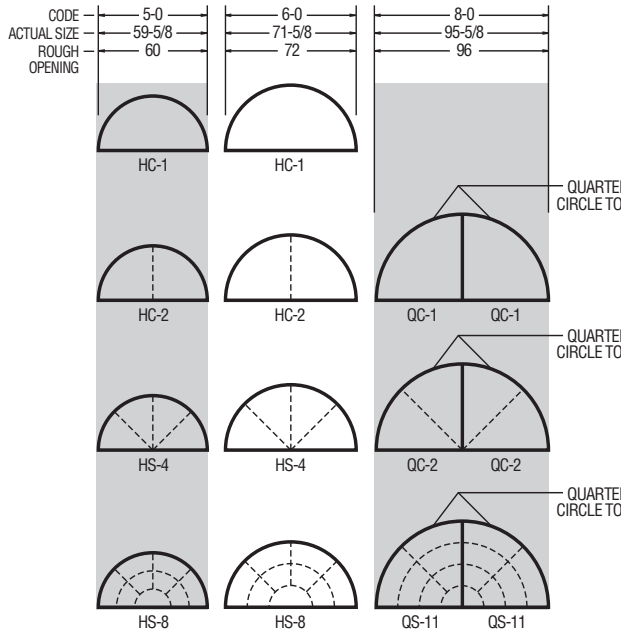

Seeing You Through.

CIRCLE TOP WINDOW SIZES



TRANSOM WINDOW SIZES

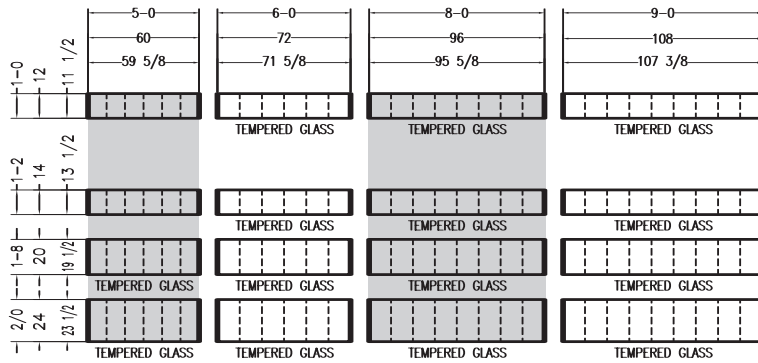

TRANSOM SIDE LITE WINDOW SIZES

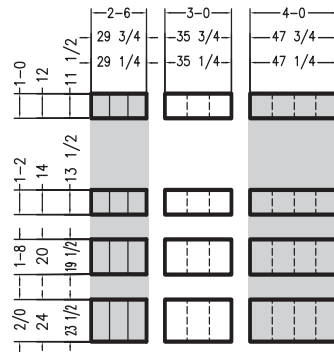

PATIO DOOR SIZES

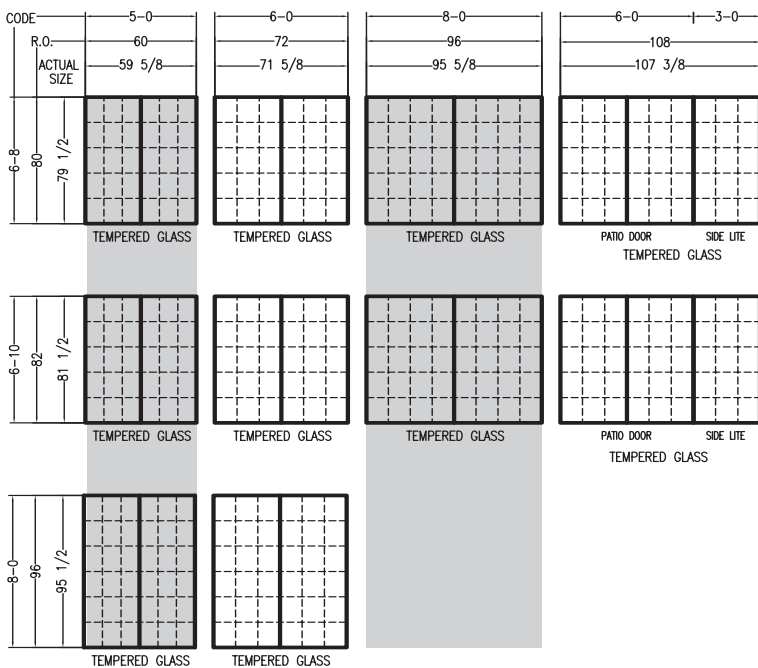

SIDE LITE WINDOW SIZES

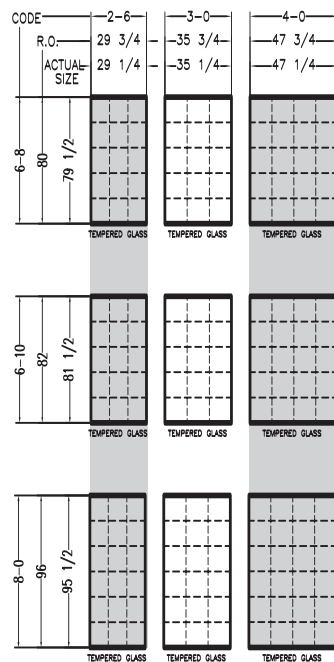

910 VINYL ROLLING PATIO DOOR

SIZES

VERTICAL DETAIL

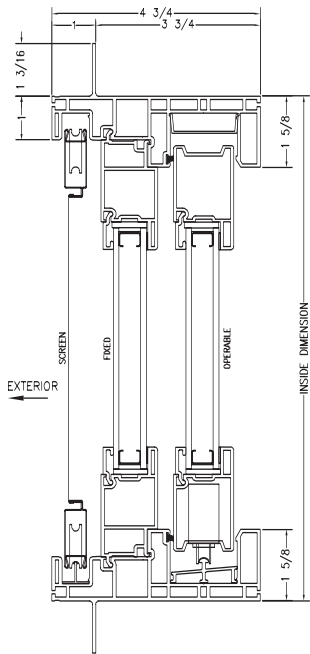

VERTICAL DETAIL WITH J-CHANNEL

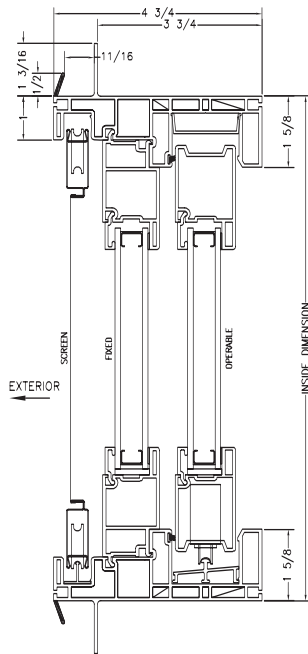

VERTICAL DETAIL WITH BRICKMOULD

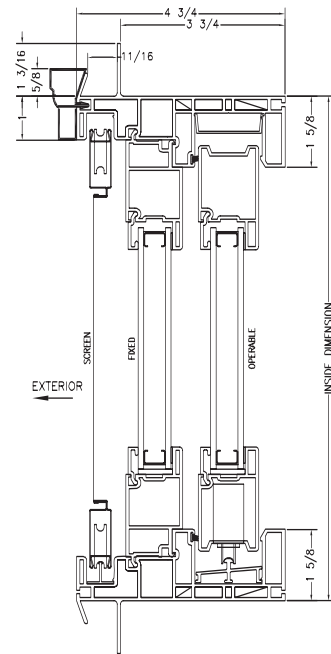

HORIZONTAL DETAIL

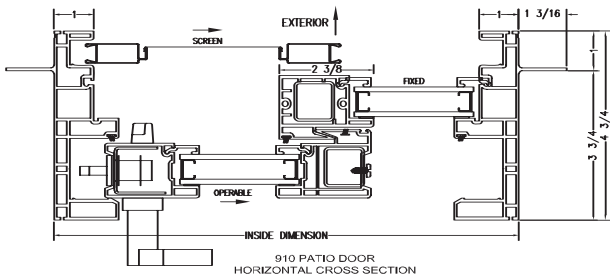

HORIZONTAL DETAIL WITH J-CHANNEL

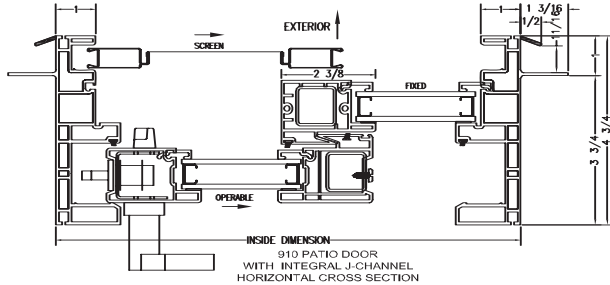

HORIZONTAL DETAIL WITH BRICKMOULD

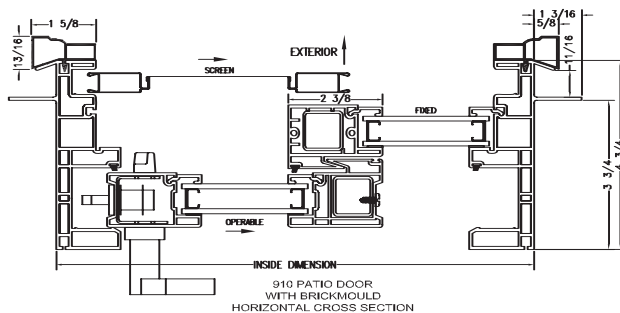

1" Fin Setback is standard.
1 3/8" Fin Setback is optional.

HORIZONTAL MULLION DETAIL

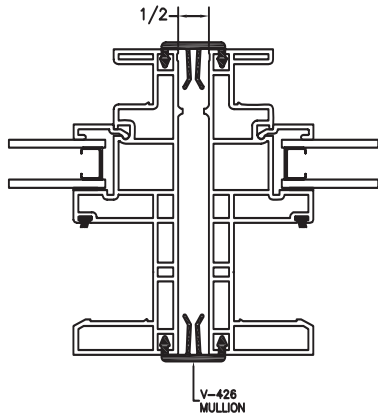

TRANSOM STRUCTURAL MULLION DETAIL

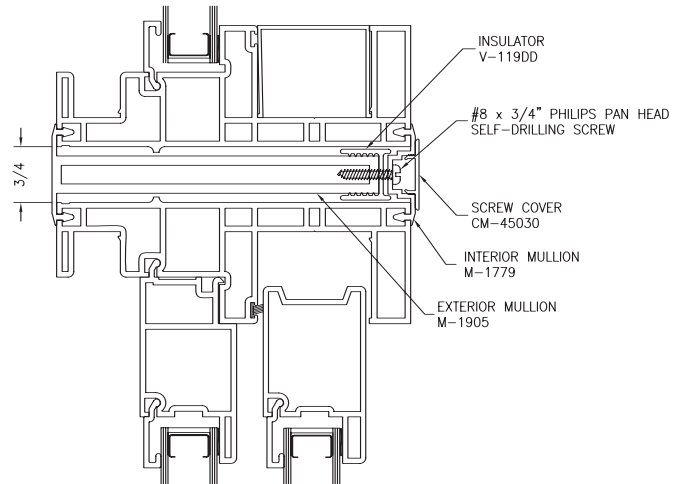

FRAME EXTENDERS FOR USE WITH 1/2" OR 5/8" DRYWALL

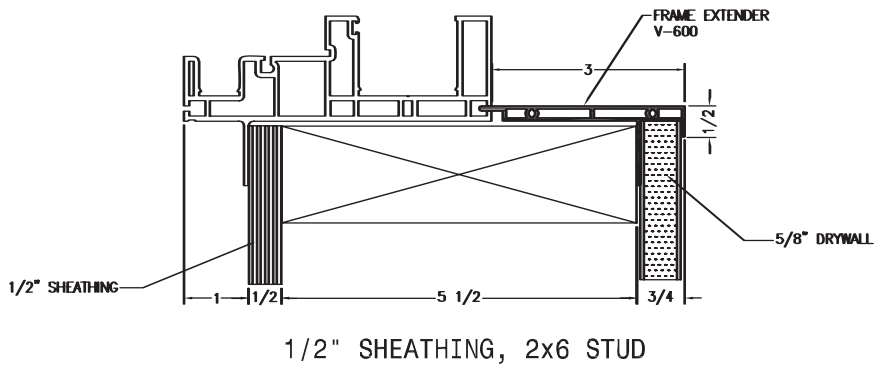

NOMINAL UNIT SIZE	ACTUAL FRAME SIZE	CLEAR OPENING Width x Height Panel Slid	VISIBLE LIGHT Total Sq. Ft.	MOVING PANEL SIZE Width x Height	SCREEN SIZE Width x Height	GLASS SIZE Width x Height
2 Panel Doors						
5/0 x 6/8 (ox/xo)	59-5/8 x 79-1/2	24-1/4 x 76-1/4	26.10	30-3/4 x 77-1/4	31 x 77-13/16	26-15/16 x 73-7/16
5/0 x 6/10 (ox/xo)	59-5/8 x 81-1/2	24-1/4 x 78-1/4	26.82	30-3/4 x 79-1/4	31 x 79-13/16	26-15/16 x 75-7/16
5/0 x 8/0 (ox/xo)	59-5/8 x 95-1/2	24-1/4 x 92-1/4	31.86	30-3/4 x 93-1/4	31 x 93-13/16	26-15/16 x 89-7/16
6/0 x 6/8 (ox/xo)	71-5/8 x 79-1/2	30-1/4 x 76-1/4	32.13	36-3/4 x 77-1/4	37 x 77-13/16	32-15/16 x 73-7/16
6/0 x 6/10 (ox/xo)	71-5/8 x 81-1/2	30-1/4 x 78-1/4	33.02	36-3/4 x 79-1/4	37 x 79-13/16	32-15/16 x 75-7/16
6/0 x 8/0 (ox/xo)	71-5/8 x 95-1/2	30-1/4 x 92-1/4	39.23	36-3/4 x 93-1/4	37 x 93-13/16	32-15/16 x 89-7/16
8/0 x 6/8 (ox/xo)	95-5/8 x 79-1/2	42-1/4 x 76-1/4	44.20	48-3/4 x 77-1/4	49 x 77-13/16	44-15/16 x 73-7/16
8/0 x 6/10 (ox/xo)	95-5/8 x 81-1/2	42-1/4 x 78-1/4	45.42	48-3/4 x 79-1/4	49 x 79-13/16	44-15/16 x 75-7/16
2 Panel Doors With Standard Side Lite						
9/0 x 6/8 (oxo) (Side Lite included)	107-3/8 x 79-1/2	30-1/4 x 76-1/4	48.20	36-3/4 x 77-1/4	37 x 77-13/16	32-15/16 x 73-7/16
9/0 x 6/10 (oxo) (Side Lite included)	107-3/8 x 81-1/2	30-1/4 x 78-1/4	49.53	36-3/4 x 79-1/4	37 x 79-13/16	32-15/16 x 75-7/16
910 Side Lite Units						
2/6 x 6/8	29-1/4 x 79-1/2	N/A	15.93	N/A	N/A	26-15/16 x 73-7/16
2/6 x 6/10	29-1/4 x 81-1/2	N/A	16.93	N/A	N/A	26-15/16 x 75-7/16
2/6 x 8/0	29-1/4 x 95-1/2	N/A	17.93	N/A	N/A	26-15/16 x 89-7/16
3/0 x 6/8	35-1/4 x 79-1/2	N/A	16.07	N/A	N/A	32-15/16 x 73-7/16
3/0 x 6/10	35-1/4 x 81-1/2	N/A	17.07	N/A	N/A	32-15/16 x 75-7/16
3/0 x 8/0	35-1/4 x 95-1/2	N/A	18.07	N/A	N/A	32-15/16 x 89-7/16
4/0 x 6/8	47-1/4 x 79-1/2	N/A	22.10	N/A	N/A	44-15/16 x 73-7/16
4/0 x 6/10	47-1/4 x 81-1/2	N/A	23.10	N/A	N/A	44-15/16 x 75-7/16
4/0 x 8/0	47-1/4 x 95-1/2	N/A	24.10	N/A	N/A	44-15/16 x 89-7/16
910 Transom Units						
*3/0 x 1/0	35-1/4 x 11-1/2	N/A	1.82	N/A	N/A	32-15/16 x 9-3/16
*3/0 x 1/2	35-1/4 x 13-1/2	N/A	2.26	N/A	N/A	32-15/16 x 11-3/16
*3/0 x 1/8	35-1/4 x 19-1/2	N/A	3.59	N/A	N/A	32-15/16 x 17-3/16
*3/0 x 2/0	35-1/4 x 23-1/2	N/A	4.48	N/A	N/A	32-15/16 x 21-3/16
*4/0 x 1/0	47-1/4 x 11-1/2	N/A	2.50	N/A	N/A	44-15/16 x 9-3/16
*4/0 x 1/2	47-1/4 x 13-1/2	N/A	3.11	N/A	N/A	44-15/16 x 11-3/16
*4/0 x 1/8	47-1/4 x 19-1/2	N/A	4.94	N/A	N/A	44-15/16 x 17-3/16
*4/0 x 2/0	47-1/4 x 23-1/2	N/A	6.16	N/A	N/A	44-15/16 x 21-3/16
910 Transom Units						
**5/0 x 1/0	59-5/8 x 11-1/2	N/A	3.20	N/A	N/A	57-5/16 x 9-3/16
**5/0 x 1/2	59-5/8 x 13-1/2	N/A	3.98	N/A	N/A	57-5/16 x 11-3/16
**5/0 x 1/8	59-5/8 x 19-1/2	N/A	6.33	N/A	N/A	57-5/16 x 17-3/16
**5/0 x 2/0	59-5/8 x 23-1/2	N/A	7.89	N/A	N/A	57-5/16 x 21-3/16
**6/0 x 1/0	71-5/8 x 11-1/2	N/A	3.88	N/A	N/A	69-5/16 x 9-3/16
**6/0 x 1/2	71-5/8 x 13-1/2	N/A	4.83	N/A	N/A	69-5/16 x 11-3/16
**6/0 x 1/8	71-5/8 x 19-1/2	N/A	7.68	N/A	N/A	69-5/16 x 17-3/16
**6/0 x 2/0	71-5/8 x 23-1/2	N/A	9.58	N/A	N/A	69-5/16 x 21-3/16
**8/0 x 1/0	95-5/8 x 11-1/2	N/A	5.25	N/A	N/A	93-5/16 x 9-3/16
**8/0 x 1/2	95-5/8 x 13-1/2	N/A	6.53	N/A	N/A	93-5/16 x 11-3/16
**8/0 x 1/8	95-5/8 x 19-1/2	N/A	10.38	N/A	N/A	93-5/16 x 17-3/16
**8/0 x 2/0	95-5/8 x 23-1/2	N/A	12.94	N/A	N/A	93-5/16 x 21-3/16
**9/0 x 1/0	107-3/8 x 11-1/2	N/A	5.96	N/A	N/A	105-5/16 x 9-3/16
**9/0 x 1/2	107-3/8 x 13-1/2	N/A	7.41	N/A	N/A	105-5/16 x 11-3/16
**9/0 x 1/8	107-3/8 x 19-1/2	N/A	11.75	N/A	N/A	105-5/16 x 17-3/16
**9/0 x 2/0	107-3/8 x 23-1/2	N/A	14.64	N/A	N/A	105-5/16 x 21-3/16

*Transoms are sized to match Side Lites.
 **Transoms are sized to match Patio Doors.

Individual products may be subject to a variation in performance.



Some products may require special glazing options to meet certain Energy Star criteria. Contact your sales representative for more information.

Energy Star qualified products use less energy than conventional products. You save money and help save the environment. We are proud to be an Energy Star partner.

FOR ADDITIONAL PRODUCT INFORMATION,
 TECHNICAL DOCUMENTS, INSTALLATION
 INSTRUCTIONS AND WARRANTY INFORMATION,
 PLEASE VISIT: WWW.MIWD.COM



Seeing You Through.

650 WEST MARKET STREET GRATZ, PA 17030 ■ 717-365-3300 ■ WWW.MIWD.COM



QUALITY CONTROL & TESTING
AAMA CERTIFICATION PROGRAM
 ACCREDITED BY: AMERICAN NATIONAL STANDARDS INSTITUTE
 Validator ALI® CODE: MTL-9

AAMA Certification insures labeled products comply with industry specifications related to windload, air infiltration and water resistance requirements.



NFRC rated products provide you with an industry standard energy efficiency testing and ratings comparison. Meet your demands for energy performance at a glance.