

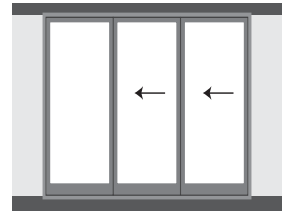

EC Multi-Slide Patio Door Installation Guide

2-Track Door • 3-Track Door • 4-Track Door



Installation Recommendations for Fin Frame Doors

These installation recommendations are made available by MI Windows and Doors, LLC (MI) to assist with the integration of mounting fin sliding glass doors into a typical wood-framed structure less than three stories in height. Installation into other structures and frame types are not addressed here.

Please contact MI or visit www.miwindows.com for additional information.

Important Design Considerations

Read this entire document before proceeding with installation of MI's products. Responsibility for product selection and installation rests with the owner, architect, and installer. Do not proceed with installation unless all factors necessary to properly integrate MI's products into a building's water management system have been addressed.

MI makes no representation or warranty that these recommendations include all information necessary to ensure proper integration into every building. State and local code requirements may impose different or additional demands, which will supersede these recommendations. For additional guidance regarding installation of door products refer to applicable industry standards (e.g., AAMA 2400, AAMA InstallationMasters™, ASTM E 2112).

Failure to follow these recommendations, local requirements, or good building practices may affect the availability of remedies under MI's warranty. Provide a copy of these recommendations and the applicable MI warranty to the owner before installing. MI does not permit adoption of its installation recommendations into the contracts of others without its prior, written consent.

Manufacturer's Note:

It is highly recommended that Multi-Slide systems are installed in areas with sufficient overhangs as required to prevent water or air infiltration. Failure to do so may result in structural damage to the surrounding area, finishes and/or systems.

It is also recommended that Multi-Slide Patio Door systems are installed by a certified installer, using a sill pan.

Important Pre-Installation Considerations

- Door installation may disturb finish surfaces and paint in existing structures. Specific notice and work site precautions may be required. Additional information is available at www.epa.gov/lead. Comply with all applicable federal, state, and local requirements.
- Job site and worker protections are recommended and may be required. Follow all manufacturers' instructions for appropriate and safe use of protective equipment, tools, materials, hardware and site protections necessary for installation.
- Special disposal considerations may be necessary for materials used during installation. Materials removed from an existing structure may also have their own disposal or recycling requirements. Comply with all applicable federal, state, and local requirements.
- Product specification sheets include important information regarding your product and may include additional installation recommendations, such as fastener use with impact resistant doors, finishing instructions, and appropriate use of low expansive foam insulation.

Contact MI for product specifications and additional product information for your MI product.

Materials Required

Non-compressible shims.

Flexible membrane sill pan flashing system.

Fasteners. Type and number as required by code. At a minimum, fastener type should be sufficient to properly affix the frame and penetrate rough opening by 1" or more.

- High quality compatible exterior grade sealant.
- Seal tape for the weather resistive barrier*.
- Self-adhering flashing, in a width required by code but no less than 4". AAMA 711 compliant flexible butyl tape flashing or equivalent is recommended.*
- Backer rod.*
- Low-expansive, low-pressure foam or batt type insulation.*

Tools Required

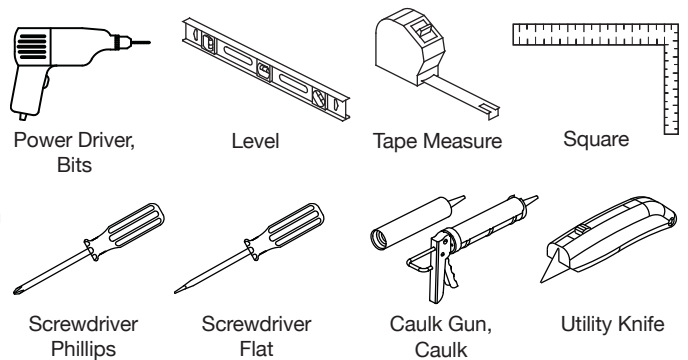

* Use and placement of these materials may be required by code, plan, or good building practices.



EC Multi-Slide Patio Door Panels
Standard parts

- Complete door panels 2, 3, or 4 panels with:
 - A. Rollers
 - B. Mortise
 - C. Interlock
 - D. Dust plugs
 - E. Sealing bridge
 - F. Bottom fin end cap

- Fix panel retainer bracket (qty 1)
(die #4221) White or Adobe

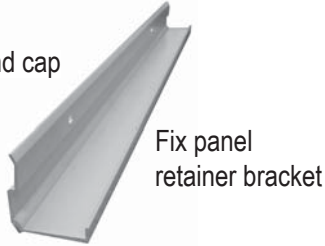

- Retainer bracket screws #8 x 1/2" (qty 8)
White (FS00137C) or Adobe (FS00137J)

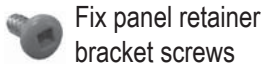

- Signature handle set (qty 1)
Recessed exterior & pull interior
White, Adobe, or Zebra



- Cone bumper (qty 1)
White (IM20700C), Adobe (IM20700J), or Black (IM20700L)



- Bumper screw (qty 1)
#8 x 1" Tek (FS00309C)



- Button plugs (2 per panel)
White (WS30025C) or Adobe (WS30025J)



- Collector plate (1 per I panel)
White or Adobe



- Collector plate screws #6 x 1 PFH (qty 5 per plate)
White (FS001550) Adobe (FS00155D)



Complete Door panels
1A - 1F

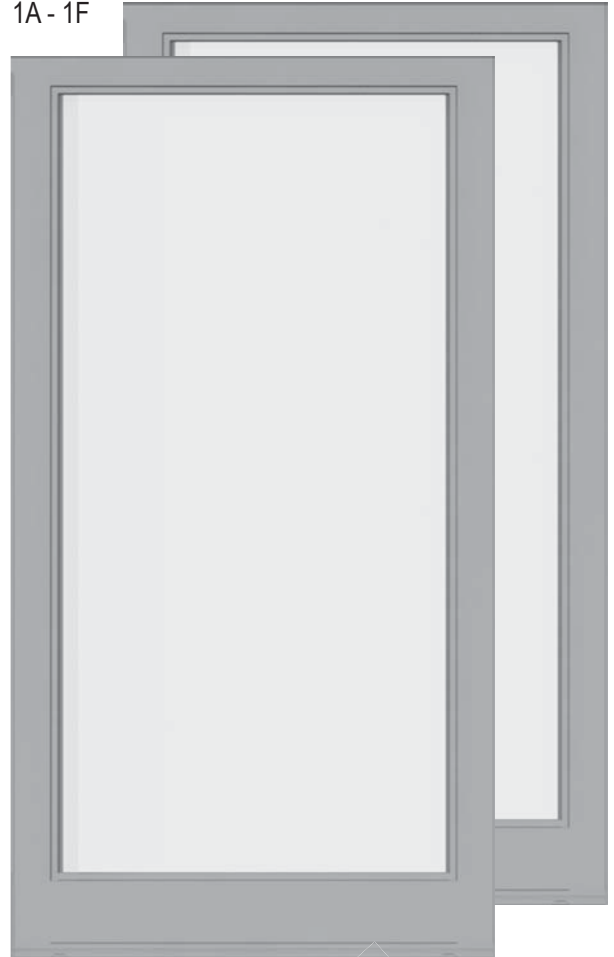

- Gaskets (qty 2)



- Optional 1" Fin
Only included if ordered.



Optional - Dual pull handle and angle bumper

- Signature handle set (qty 1)
Dual pull
White, Adobe, Zebra, Brushed Nickel, and Oil Rubbed Bronze

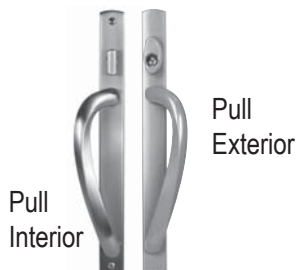

- Angle Bumper (1 per operating panel)
White or Adobe



- Bumper screws (qty 3)
#8 x 1" Tek (FS00309C)



Standard parts for EC Multi-Slide Patio Door Frame Kit

1. Frame Kit (1)
head, sill and side jambs
2. Panel stop (1 per operating panel)
White, Adobe, or Bronze
3. Frame screws (1 pkg)
4. Installation screws (1 pkg)
5. Three point lock keeper - installed (1)
6. "L" bracket (1 per "I" panel)
7. 1-3/8" Aluminum mounting fin

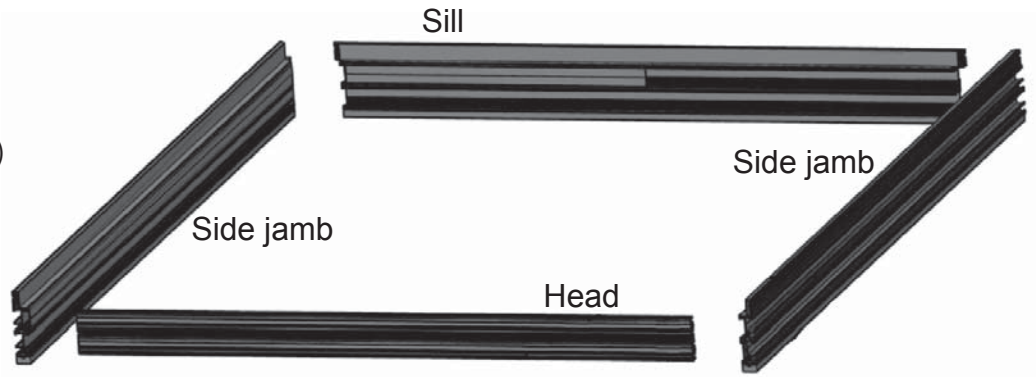

Frame & installation screws

Option: 1" Sealing flange

Opening Preparation

Inspect the rough opening prior to installation.

Confirm that the roof over the system is stacked and take into consideration the amount of weight of any materials at this location that may cause deflection of the header. No more than 1/8" deflection is allowable for proper system operation.

Verify that the concrete or sub-floor where the system is to be installed is level. The frame system may be shimmed to compensate for an uneven floor but will adjust the relationship of the systems sill to the finished floor and may increase the overall height of the system in the opening. Any serious deflection in the concrete or sub-floor where the system is to be installed must be corrected prior to installation.

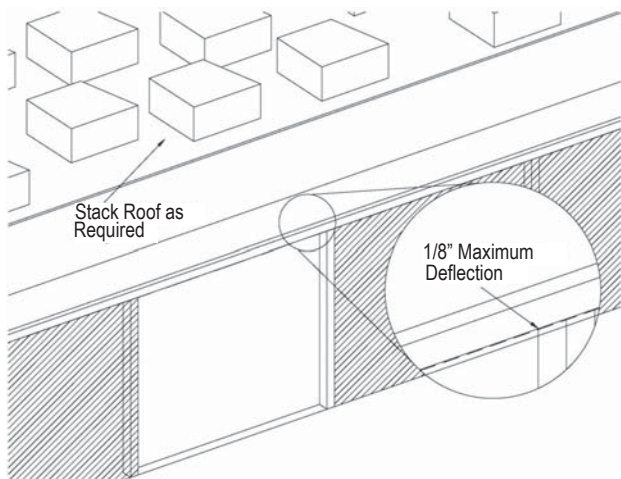

Assure that all opening measurements match those noted on the drawings that are provided with the system.

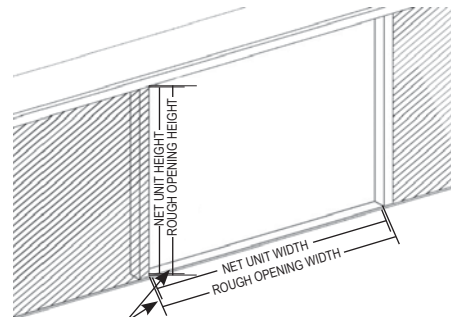
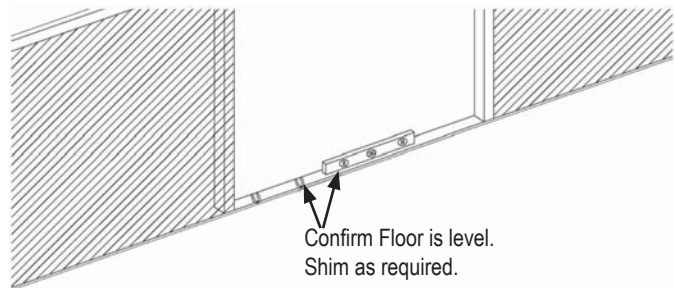

Verify unit and rough opening dimensions match drawing provided. (see rough opening charts on pages 7 & 8.)

Frame Assembly

Lay frame head, sill and side jamb(s) on a flat surface with the exterior side up.

Align the left side jamb to the outside top left edge of the head.

Attach the left side jamb to the head using screws supplied in the “Jamb Assembly” screw package.

Repeat to attach right side jamb to head.

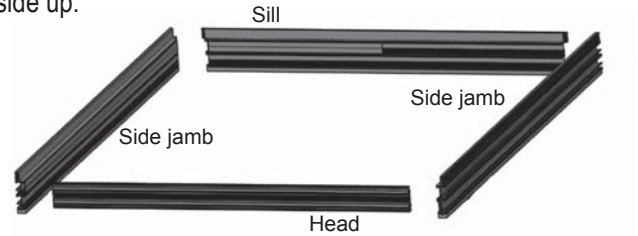

Align left side jamb to the outside bottom edge of the sill. Attach the left side jamb to sill using screws supplied in the screw package.

Repeat step to attach right side jamb.

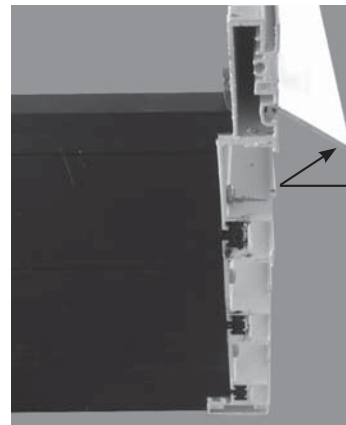

Sill Plate Flashing and Sealant - RECOMMENDATIONS

Installation of a moisture barrier on the concrete or sub-floor and flashing at the top and sides is recommended in accordance with building codes and/or acceptable practices in your area.

If the system is to be installed over a wood sub-floor, a sill pan or self sticking flashing is recommended at the sill.

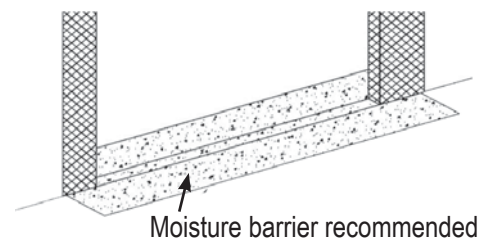

Frame Installation

Stand-up assembled frame and dry fit the frame in prepared opening. Using a straight edge and/or level to verify that the sill is level. Use shims as necessary to level and flatten the frame sill to the floor. Mark the sill on the inside with a pencil line on the floor to identify where the sill is located for final installation. For a cement floor pre-drill pilot holes with a hammer drill in the floor through the pre-drilled door sill.

Remove assembled frame and clean floor in preparation of final installation. For a cement floor finish drilling each hole to accommodate a Tapcon masonry fastener.

Apply a generous bead of sealant down the length of the floor on the inside and outside edge of where the frame sill will sit. Also apply generous beads of sealant perpendicular and in-line with the pre-drilled holes in the sill.

Before reinstalling the assembled frame apply additional sealant to the exterior joints of the frame, head to jamb and sill to jamb locations.

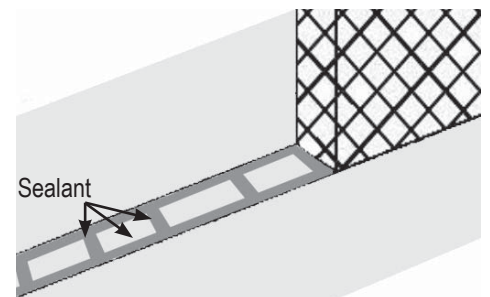

Frame Installation continued

Stand-up assembled frame and set in prepared opening for final installation. Align sill to previous drawn pencil line on the floor. Using a straight edge and/or level to confirm sill is level. Position any of the previous shims to level and flatten the frame sill to the floor. Cross measure the frame to confirm there is no variance larger than 3/16" per measurement and that the frame is square to within 1/8" horizontally and vertically.

Prior to attaching the head to the prepared opening, square the frame to within the allowable tolerances. Using a straight edge and/or level, verify that the top track/head is level and flat. Use shims as needed to level and flatten the head.

Install 2-3 screws in the head through the pre-drilled holes using the screws located in the head install screw package.

The remaining screws will be installed after the panels are installed. Using a straight edge and/or level, verify that the side jambs are level and flat. Use shims as needed to level and flatten the jambs.

Install 2 screws per jamb through the factory pre-drilled holes using the screws located in the screw package. The remaining screws will be installed after the panels are installed. Attach sill to floor with screws provided through pre-drilled holes, per cross section drawing. **DO NOT** attach screws through the pre-drilled weep holes.

Panel Installation

Refer to the chart and configuration drawings on pages 7 and 8 to install door panels in the correct order. 2-Track doors with 2, 3, and 4 panel configurations are on page 7, 3-Track doors with 3 panels and 4-Track doors with 4 panels are on page 8.

All door configurations with a fixed panel "O" will require the installation of a retainer bracket. Install the fixed panel retainer bracket in frame jamb where the "O" panel will be installed. Attach retainer bracket with #8 x 1/2" screws through pre-punched holes. Do not affix the retainer bracket to the "O" panel at this time.

Beginning with the first panel to be installed, hold the panel at an angle toward the head track, insert the top of the panel into the inner most head track and swing the bottom of the panel inward until it is parallel with the top and sits with the wheels on the corresponding sill. Push the first panel installed fully to the fixed panel jamb.

Repeat step for all remaining panels in sequential order.

Handle Installation

Standard Handle Set

Signature Series interior pull and a recessed exterior handle. The standard handle set is boxed with a full set of instructions on how to install.

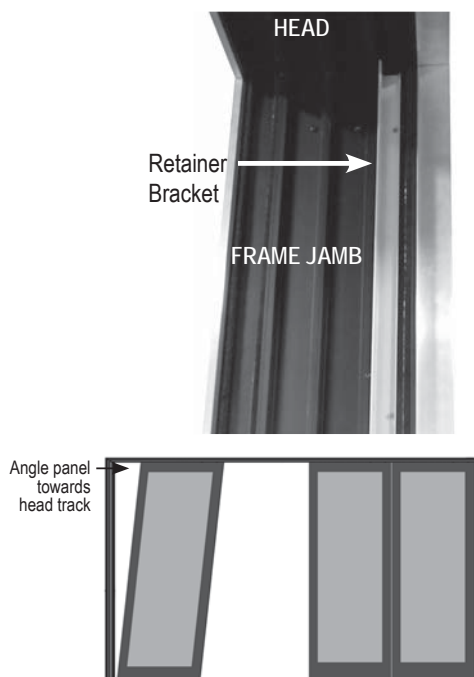
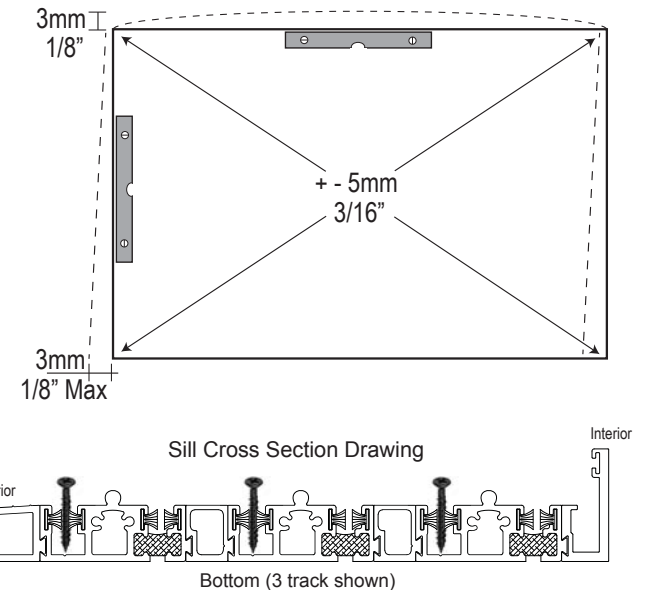

Optional Handle Set

Signature Series dual pull handle with a key-lock. The optional handle set is boxed with a full set of instructions on how to install.



Wheel Adjustments

Once all panels are installed, close the system and make sure all panel stiles line up properly by adjusting wheels for proper alignment.

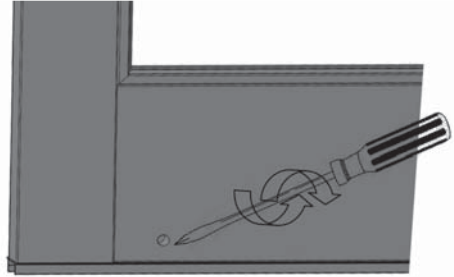

Lock and Slide

Perform a lock and slide before you continue with the next steps. Open, close, lock and repeat.

Secure “O” Panel

Secure the “O” panel to the fix panel retainer bracket with #8 x 1/2” screws through the pre-punched holes.

Install the remaining frame screws into the head and jambs through the factory pre-drilled holes.

Fasten the mounting fins to the studs on head and jambs.

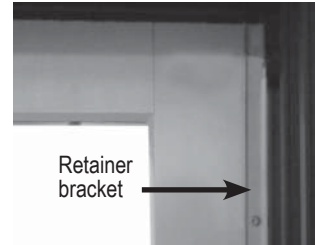

Collector Plate Installation

3 Panel Door

Install collector plate on interior “I” panel jamb, 3/4” from top of panel with screws provided.



4 Panel Door

Install collector plate on interior “I” panel jamb, 3/4” from top of panel with screws provided. Center the second collector plate so the tab nests in the opening of the first plate installed.

Cone Bumper Installation

Attach cone bumper on the interior side jamb in the track next to the fixed panel, 3” down from head with the bumper screw provided.



Optional Angle Bumper

Attach angle bumper to the bottom of the interior jamb of each “I” panel. Locate the bumper on center, 4” up from bottom of the panel and 2” over from the side of the jamb.



“L” Bracket Installation

Install panel stop “L” bracket into the head next to the “I” panel when it is fully closed and locked.

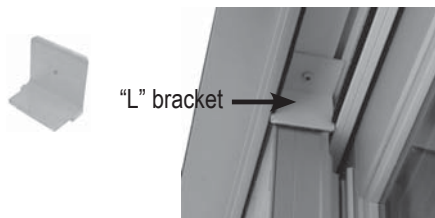

Install Button Plugs

Install button plugs into the wheel adjustment holes when finished.



2 Track Door *(There are 2, 3, and 4 Panel - 2 Track Doors available)*

Configurations, sizes, and panel installation order

Shown as viewed from outside.

2 - Track Door	Door Configuration	Panel Installation Order	Fixed Panel Retainer Bracket
2 - Panel	XX OX XO	A then E E then A F then B	N/A Yes - Left Jamb Yes - Right Jamb
3 - Panel	OX-O O-XO	E, A then I F, B then J	Yes - Lt & Rt Jamb Yes - Lt & Rt Jamb
4 - Panel	OXXO XXXX	C, G, then A, B C, G, then A, B	Yes - Lt & Rt Jamb N/A

2 Track / 2 Panel

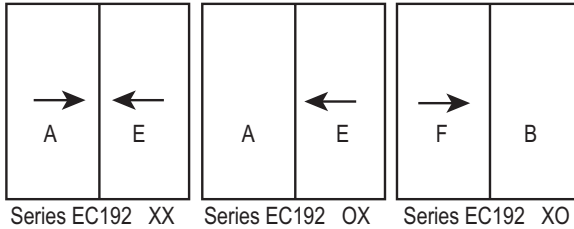

Nominal Size	Configuration	Exact Dimension	Rough Opening
5'-0" x 6'-8"	OX, XO, XX	59 3/4" x 79 1/4"	60 1/4" x 79 3/4"
6'-0" x 6'-8"	OX, XO, XX	71 3/4" x 79 1/4"	72 1/4" x 79 3/4"
8'-0" x 6'-8"	OX, XO, XX	95 3/4" x 79 1/4"	96 1/4" x 79 3/4"
10'-0" x 6'-8"	OX, XO, XX	119 3/4" x 79 1/4"	120 1/4" x 79 3/4"
5'-0" x 8'-0"	OX, XO, XX	59 3/4" x 95 1/4"	60 1/4" x 95 3/4"
6'-0" x 8'-0"	OX, XO, XX	71 3/4" x 95 1/4"	72 1/4" x 95 3/4"
8'-0" x 8'-0"	OX, XO, XX	95 3/4" x 95 1/4"	96 1/4" x 95 3/4"
10'-0" x 8'-0"	OX, XO, XX	119 3/4" x 95 1/4"	120 1/4" x 95 3/4"

2 Track / 3 Panel

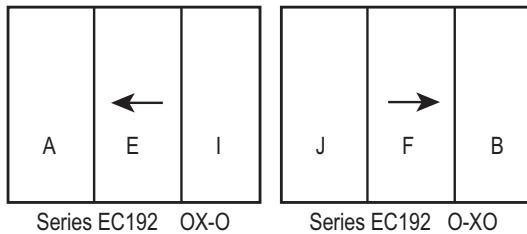

Nominal Size	Configuration	Exact Dimension	Rough Opening
7'-6" x 6'-8"	OX-O, O-XO	91 11/16" x 79 1/4"	92 3/16" x 79 3/4"
9'-0" x 6'-8"	OX-O, O-XO	109 11/16" x 79 1/4"	110 3/16" x 79 3/4"
12'-0" x 6'-8"	OX-O, O-XO	145 11/16" x 79 1/4"	146 3/16" x 79 3/4"
7'-6" x 8'-0"	OX-O, O-XO	91 11/16" x 95 1/4"	92 3/16" x 95 3/4"
9'-0" x 8'-0"	OX-O, O-XO	109 11/16" x 95 1/4"	110 3/16" x 95 3/4"
12'-0" x 8'-0"	OX-O, O-XO	145 11/16" x 95 1/4"	146 3/16" x 95 3/4"

2 Track / 4 Panel

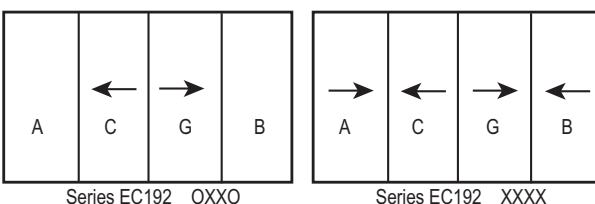

Nominal Size	Configuration	Exact Dimension	Rough Opening
10'-0" x 6'-8"	OXXO	119 1/8" x 79 1/4"	119 5/8" x 79 3/4"
12'-0" x 6'-8"	OXXO	143 1/8" x 79 1/4"	143 5/8" x 79 3/4"
16'-0" x 6'-8"	OXXO	191 1/8" x 79 1/4"	191 5/8" x 79 3/4"
10'-0" x 8'-0"	OXXO	119 182" x 95 1/4"	119 5/8" x 95 3/4"
12'-0" x 8'-0"	OXXO	143 1/8" x 95 1/4"	143 5/8" x 95 3/4"
16'-0" x 8'-0"	OXXO	191 1/8" x 95 1/4"	191 5/8" x 95 3/4"

3 Track Door

Configurations, sizes, and panel installation order

Shown as viewed from outside.

3 - Track Door	Door Configuration	Panel Installation Order	Fixed Panel Retainer Bracket
3 - Panel	XIX OIX XIO	A, C, then E E, C, then A F, D, then B	N/A Yes - Left Jamb Yes - Right Jamb

Nominal Size	Configuration	Exact Dimension	Rough Opening
7'-6" x 6'-8"	OIX, XIO, XIX	87 1/8" x 79 1/4"	87 5/8" x 79 3/4"
9'-0" x 6'-8"	OIX, XIO, XIX	105 1/8" x 79 1/4"	105 5/8" x 79 3/4"
12'-0" x 6'-8"	OIX, XIO, XIX	141 1/8" x 79 1/4"	141 5/8" x 79 3/4"
15'-0" x 6'-8"	OIX, XIO, XIX	177 1/8" x 79 1/4"	177 5/8" x 79 3/4"
7'-6" x 8'-0"	OIX, XIO, XIX	87 1/8" x 95 1/4"	87 5/8" x 95 3/4"
9'-0" x 8'-0"	OIX, XIO, XIX	105 1/8" x 95 1/4"	105 5/8" x 95 3/4"
12'-0" x 8'-0"	OIX, XIO, XIX	141 1/8" x 95 1/4"	141 5/8" x 95 3/4"
15'-0" x 8'-0"	OIX, XIO, XIX	177 1/8" x 95 1/4"	177 5/8" x 95 3/4"

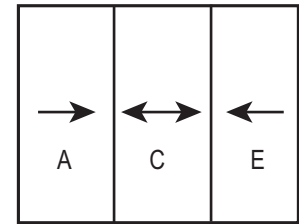

Series EC193 XIX

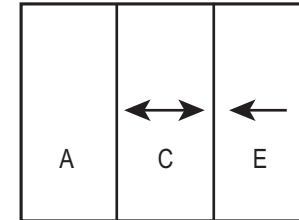

Series EC193 OIX

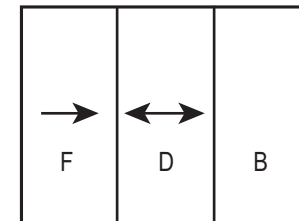

Series EC193 XIO

4 Track Door

Configurations, sizes, and panel installation order

Shown as viewed from outside.

4 - Track Door	Door Configuration	Panel Installation Order	Fixed Panel Retainer Bracket
4 - Panel	XIIX OIIX XIIO	A, C, C, then E E, C, C, then A F, D, D, then B	N/A Yes - Left Jamb Yes - Right Jamb

Nominal Size	Configuration	Exact Dimension	Rough Opening
10'-0" x 6'-8"	OIIX, XIIO, XIIX	114 1/2" x 79 1/4"	115" x 79 3/4"
12'-0" x 6'-8"	OIIX, XIIO, XIIX	138 1/2" x 79 1/4"	139" x 79 3/4"
16'-0" x 6'-8"	OIIX, XIIO, XIIX	186 1/2" x 79 1/4"	187" x 79 3/4"
10'-0" x 8'-0"	OIIX, XIIO, XIIX	114 1/2" x 95 1/4"	115" x 95 3/4"
12'-0" x 8'-0"	OIIX, XIIO, XIIX	138 1/2" x 95 1/4"	139" x 95 3/4"
16'-0" x 8'-0"	OIIX, XIIO, XIIX	186 1/2" x 95 1/4"	187" x 95 3/4"

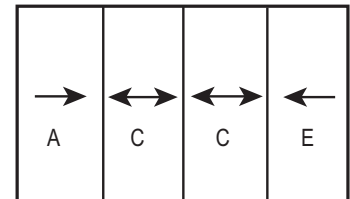

Series EC194 XIIX

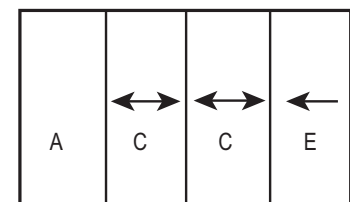

Series EC194 OIIX

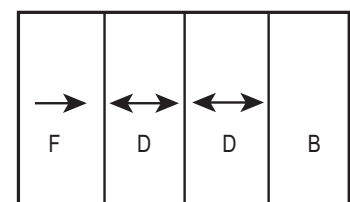

Series EC194 XIIO